

Article number: 2035024513534NI

Description: E+G Levelling sets GN 350.2-45-13.5-34-NI

## Measures

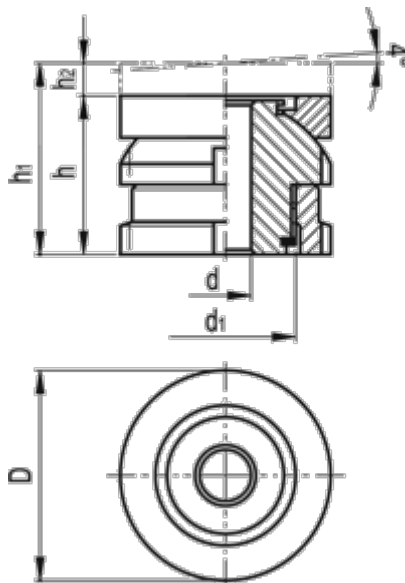

C-spanner DIN 1810 = A45-50

d = 13.5

D = 45

d1 = M30x1.5

For screw = M12

h = 34

h1 = 41

h2 = 7

Max static load (kN) = 84

Static preload (kN) = 54.82

Weight (g) = 305